

Curtain Tracks, Rails and Curtains



Curtain tracks, rails and curtains for washrooms, ensuites and wards

Contents

Curtain Track & Curtain Range	3
Shower Curtain Track.....	4
Shower Curtain Rails	5
Bedroom Tracks	6
Order Form.....	10

At GRI we stock all your curtain track and curtain needs for washrooms, ensuites and wards. The GRI curtain tracks are available in standard sizes and we also provide for your custom requirements.

The GRI curtain track systems include the Moving Rail System for theatres or bedrooms, the Ridgid Rail System for showers and bedrooms and our Intravenous Rail System for operating rooms, intensive care or areas which require intravenous feeding. Shower Curtain Rods – straight or bent – are also available.

Our quality curtains will set the look for your room or washroom, so don't forget to order these along with your curtain tracks and rods.

GRI Products reserves the right to, and does from time to time, make changes and improvements in design and dimensions. The photographs and line drawings of the products in this catalogue are representational only.

Finishes

- Clear anodised aluminium
- White
- Other powdercoated colours to order

Shower Curtain Tracks Made to Order

We can make your Curtain tracks to order. Simply supply measurements A and B.

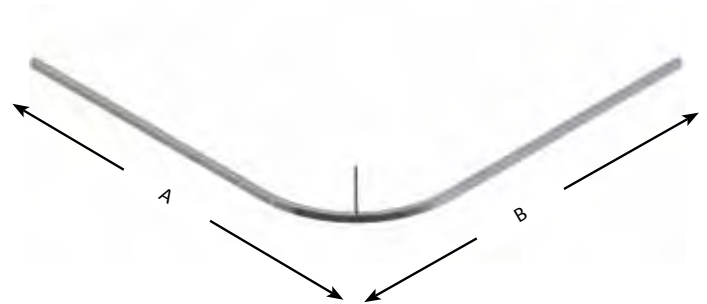

Shower Curtains - GRI 220

Made from Waterproof Oxford Nylon White with PU600, 6KPA and weighted.

All sizes available



Shower Curtain Tracks

Shower Track - Standard Sizes

Curtain Track Bent Standard Sizes

Code	Size	Degree Angle
GRI 210	1000 x 1000	90°
GRI 211	1100 x 1100	90°
GRI 212	1200 x 1200	90°
GRI 213	1300 x 1300	90°

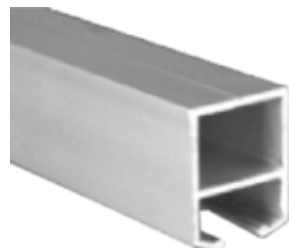
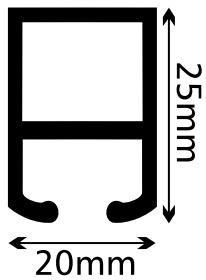

Shower Track Installation



1. Attach track socket onto wall with counter sunk screws.

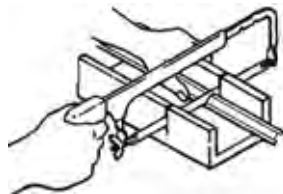

2. Cut track with hack-saw to suit exact size.



3. Insert curtain hooks into track.

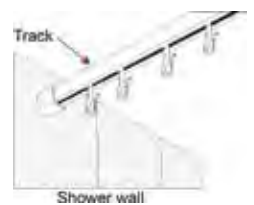

4. Attach rail into socket into each end, then fasten with counter sunk screws.

Shower Track Components

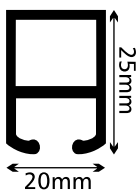

Shower Track



Wall Mounted Track Socket



Swivel Curtain Hooks



Suspension Tube



Single Point Hander Assembly

Shower Rods

Choose matching or co-ordinated colours from the Grab Rail Industries range for these standard 25mm diameter shower curtain rods, supplied to any straight length. 32mm diameter rods and custom shapes and sizes also available. Ceiling supports are required for rods above 900mm x 900mm. Supplied 1000mm long and cut to required length on site.

Shower curtain rods are screw fixed to wall surfaces. The fixing flanges are available either with exposed screws or with screws concealed by snaplock covers.

Code	Size
GRI 200	As specified



Straight size to any length



Exposed screw fixing



Concealed screw fixing



Illustration of hanger

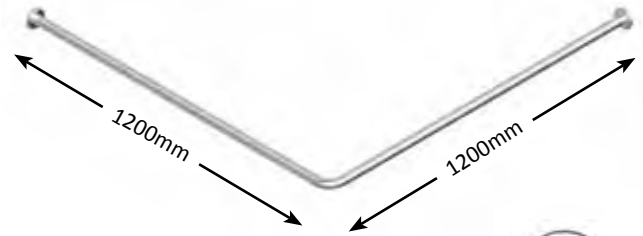
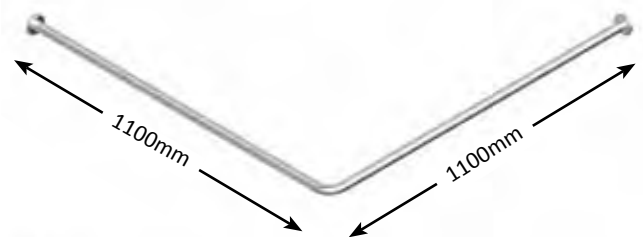
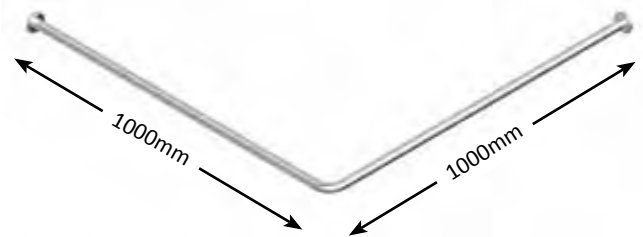

Hanger



Shower hooks

Bedroom Tracks

GRI Moving Rail System

Manufactured from aluminium in clear anodised or white epoxy finish. This is suspended on aluminium tubular hangers supported from the structural ceiling and fixed at the height as illustrated on the drawings. An anodised aluminium domed rose is fitted at the ceiling fixing point or at the point on penetration of a false suspended ceiling.

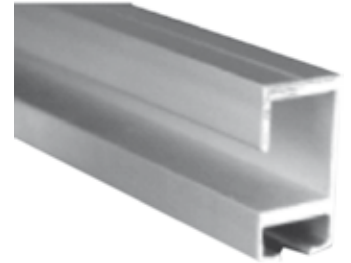
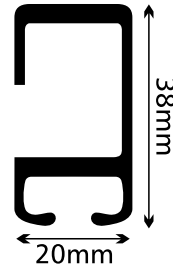
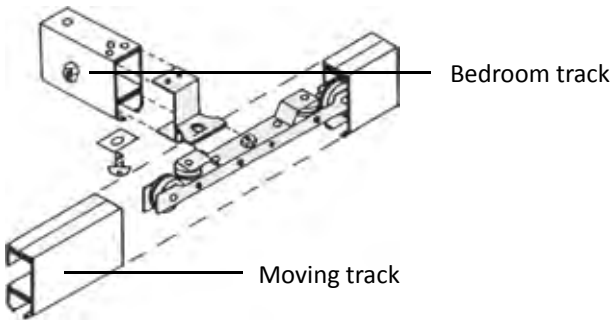

Trolley assembly



GRI Fixed Rail System

GRI's fixed rail system is manufactured from aluminium and available in clear anodised and white epoxy finish (refer components page for track colour and lengths available). Track sections 38mm height and 20mm width overall. This is suspended on aluminium tubular hangers supported from the structural ceiling and fixed at the height shown on drawings



GRI Intravenous Rail

Hospital track, including automatically locking IV carriers for medical IV tree. The oval installation is good for operating rooms and intensive care giving complete freedom of movement around beds wherever it is installed for intravenous feeding.



Five Point IV Tree Adj
900mm Ext



IV Tree Carrier



Bedroom Track with
IV Carrier



GRI Cassette Rail System

Can take curtains out of rail. *Uses: Bedrooms*
The curtain cassette is designed to allow a quick and easy change of the curtain. The cassette sits 70cm from the end of the track. An interchange of curtains can occur in one easy motion.

Installing Curtain Cassette System

These Curtain Cassette Loaders make bed screen cubicle curtain changing quick and easy. Sturdy aluminium box section matching the track system.



1. Insert curtain swivel hooks into cassette insert



2. Place cassette into the bridge at angle locating against post inside bridge



3. Withdraw release knob to assist final locking of insert



4. Draw the curtain along the track. To remove the curtain, reverse the procedure

Bedroom Tracks

Bedroom Curtain Track Installation

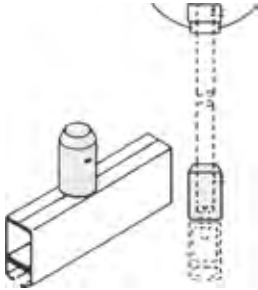

1. SINGLE POINT HANGER ASSEMBLY

The single point hanger fixes to the top of the track using a 12mm No. 6 countersunk selftapping screw. The suspension tube is locked in with a grub screw.

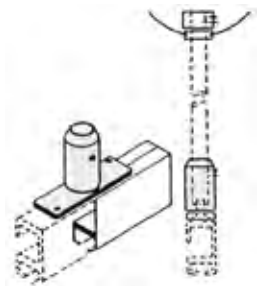

2. TWO POINT HANGER ASSEMBLY

The two point hanger assembly fixes to the top of the Monotrack using a 4.5mm No. 6 self-tapping screw. The suspension tube is locked in with a grub screw.

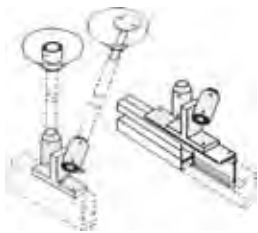

3. VEE HANGER ASSEMBLY

The vee hanger assembly is used where a standard vertical drop is required and additional support to prevent sideways movement of the track. Note: Always ensure the maximum angle is 30deg between vertical and angled suspension tube. A swivel mount bracket is best used on the other end if fixing direct to ceiling.

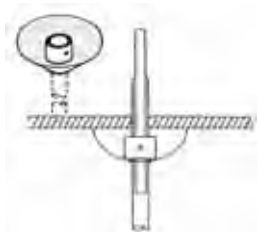

4. SUSPENSION TUBE CEILING COVER

The suspension tube ceiling cover is supplied complete with rubber grommets. It grips onto the suspension tube and holds the cover in place. The function is decorative, used to cover the suspension collar and give a neat finish to the finished installation.

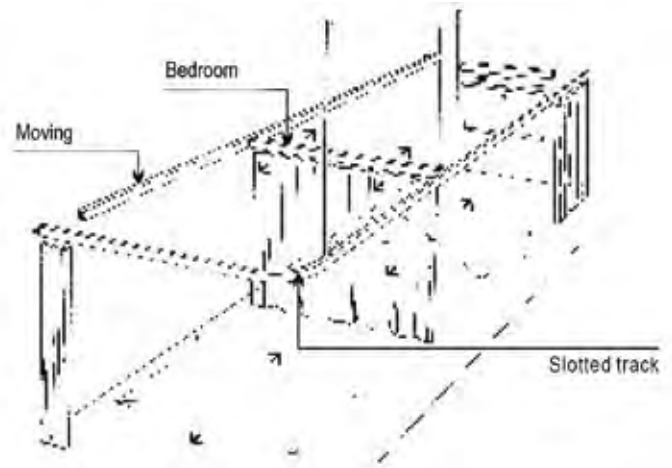

Bedroom Track Components

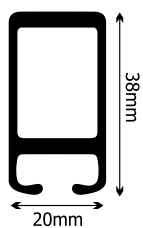

Shower Track



Wall Mounted Track Socket



Swivel Curtain Hooks



Suspension Tube



Single Point Hander Assembly



Two-point hander assembly



Internal track joiner



Solid track joining splice



Wall mount bracket

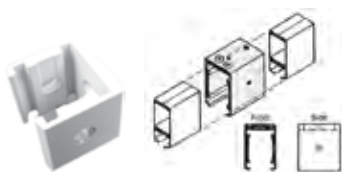

Ceiling mount clip

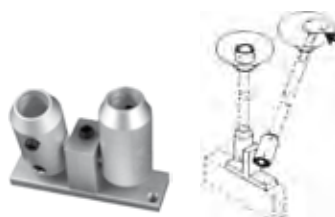

Vee-hander

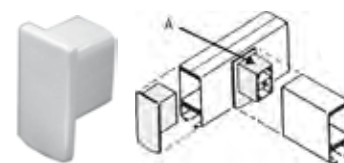

Track stop end



Steel wall bracket



Suspension tube swivel mount



Suspension tube ceiling cover

Order Form

To: Grab Rail Industries
Fax: (02)4824 1020

Attention: Sales
Email: sales@griproducts.com.au

Company: _____ Contact Name: _____

Phone: _____ Email: _____

Delivery Address: _____

Qty	Item Code	Description	Cost	Total

Methods of Payment

- Cheque/Money Order (please make out to Grab Rail Industries)
- Credit Card: Visa Mastercard Bankcard

GST	
TOTAL	

Card No.

--	--	--	--	--	--	--	--	--	--	--	--	--	--

Expiry Date: ____ / ____

Signature: _____

Our complete range of products:



Contact us for a copy of these brochures

